



Steamfast™

MODEL

SF-407



EVERYDAY FABRIC STEAMER

OWNER'S GUIDE

IMPORTANT SAFETY INSTRUCTIONS



WARNING: To reduce risk of fire, electrical shock or injury, the following basic safety precautions should always be followed when using an electrical appliance.

WARNING: To reduce the risk of electrical shock, this appliance uses a grounded (three-pronged) plug. This plug will fit in a grounded wall outlet only one way. If the plug does not correctly fit in the outlet, contact a licensed electrician to install a proper outlet. DO NOT attempt to modify the plug or defeat this safety feature.

READ ALL INSTRUCTIONS BEFORE USE



DANGER

Any appliance is electrically live even when switched off. To reduce risk of electrical shock:

1. Always unplug power cord immediately after using.
2. Do not place or store unit where it can fall or be pulled into a sink or tub.
3. Do not place in, or drop into water or other liquid.
4. If unit falls into water, immediately unplug power cord. Do not reach into the water.



WARNING

To reduce risk of burns, electrocution, fire, or injury to persons:

1. Do not tamper with or modify this product in any way. The manufacturer assumes no responsibility for damage or injury caused by failure to follow these instructions, improper use, or unauthorized product modification. Any such actions will invalidate the product warranty.
2. Use Everyday Fabric Steamer only for its intended purpose as indicated in this manual.
3. If an extension cord is necessary, use a properly rated cord (15 ampere, 14 gauge). Use care to position extension cord where it is least likely to be damaged or tripped over during use.
4. Before plugging power cord into electrical outlet, be sure that all electrical information on rating label agrees with your power supply.
5. To reduce likelihood of circuit overload, DO NOT operate another high wattage appliance on the same circuit as this unit.
6. To protect against risk of electrical shock, do not immerse unit in water or other liquids. Do not use power cord as handle, let it hang over edges of counters, or be crimped or closed in doors.
7. Never yank power cord to disconnect from outlet; instead, grasp plug and pull to disconnect.
8. Do not operate unit with a damaged power cord or if the unit has been dropped or damaged. To avoid risk of electrical shock, do not disassemble unit; contact Steamfast Consumer Service for examination and repair. Incorrect reassembly can cause a risk of electrical shock when unit is used.
9. Close supervision is required for any appliance being used near children, pets and plants. Do not leave unit unattended while plugged in.
10. This unit is not intended for use by persons (including children) with reduced physical, sensory or mental capabilities, or lack of experience and knowledge, unless they have been

given supervision or instruction concerning use of the unit by a person responsible for their safety.

11. Do not use unit where aerosol-based products are being used, or where oxygen is being administered.
12. Unit is only meant to be used with recommended Everyday Fabric Steamer (model SF-407) accessories. Using other types of attachments may cause damage to unit or injury.
13. If Lighted On/Off Switch does not illuminate when unit is plugged in and Switch is set to "ON" position, unit is not operating normally. Immediately disconnect cord from power supply, then refer to troubleshooting guide on Page 13 of this manual for assistance.
14. Do not attempt to use unit without properly filling Water Tank / Water Reservoir.
15. When filling unit, only water should be used – other cleaning agents could damage unit or cause injury. Distilled or de-mineralized water is highly recommended, in order to minimize potential build-up of mineral deposits.
16. To reduce risk of contact with hot water emitting from Steam Nozzle, check appliance before each use by positioning it away from body and turning it on. Do not operate unit if Steam Nozzle is blocked.
17. Use caution when carrying unit up stairs or over obstacles, or when using unit on or near an uneven surface.
18. Burns can occur from touching hot plastic parts, hot water, or steam. Do not touch Steam Nozzle or attempt to connect any accessories while unit is in use. Use caution when you turn unit upside-down – there may be hot water inside.
19. When steaming any fabric for the first time, it is recommended that you consult the manufacturer's guidelines for the material being steamed. For items in question, test on an inconspicuous area before proceeding.
20. Synthetic materials (such as 100% nylon or polyester) are sensitive to heat, and may be damaged by exposure to hot steam. Steam is recommended for use only on natural fibers such as cotton, linen or wool, as well as nylon or polyester blends.
21. Do not allow power cord to touch hot surfaces during use. Loosely bundle cord when storing.
22. Always allow Everyday Fabric Steamer to cool (15 minutes for complete cooling) and empty Water Tank and Water Reservoir before storing.

This equipment may generate, use and/or radiate radio frequency energy that may cause harmful interference to radio communications. If this equipment does cause harmful interference to radio or television reception, which can be determined by turning the equipment off and on, the user is encouraged to contact Steamfast Consumer Service at 1-800-711-6617.

Please refer to our website for the most current version of our owner's guide.

Questions or comments?

- steamfast.com
- consumerservice@steamfast.com
- 1-800-711-6617

Speak your mind! We invite you to review this product online:
steamfast.com/reviews

The following features and accessories are included with your Everyday Fabric Steamer. Carefully inspect the packing material for all parts listed below. To obtain possible missing parts, refer to **Product Support** on Page 14 of this manual for Consumer Service contact information.

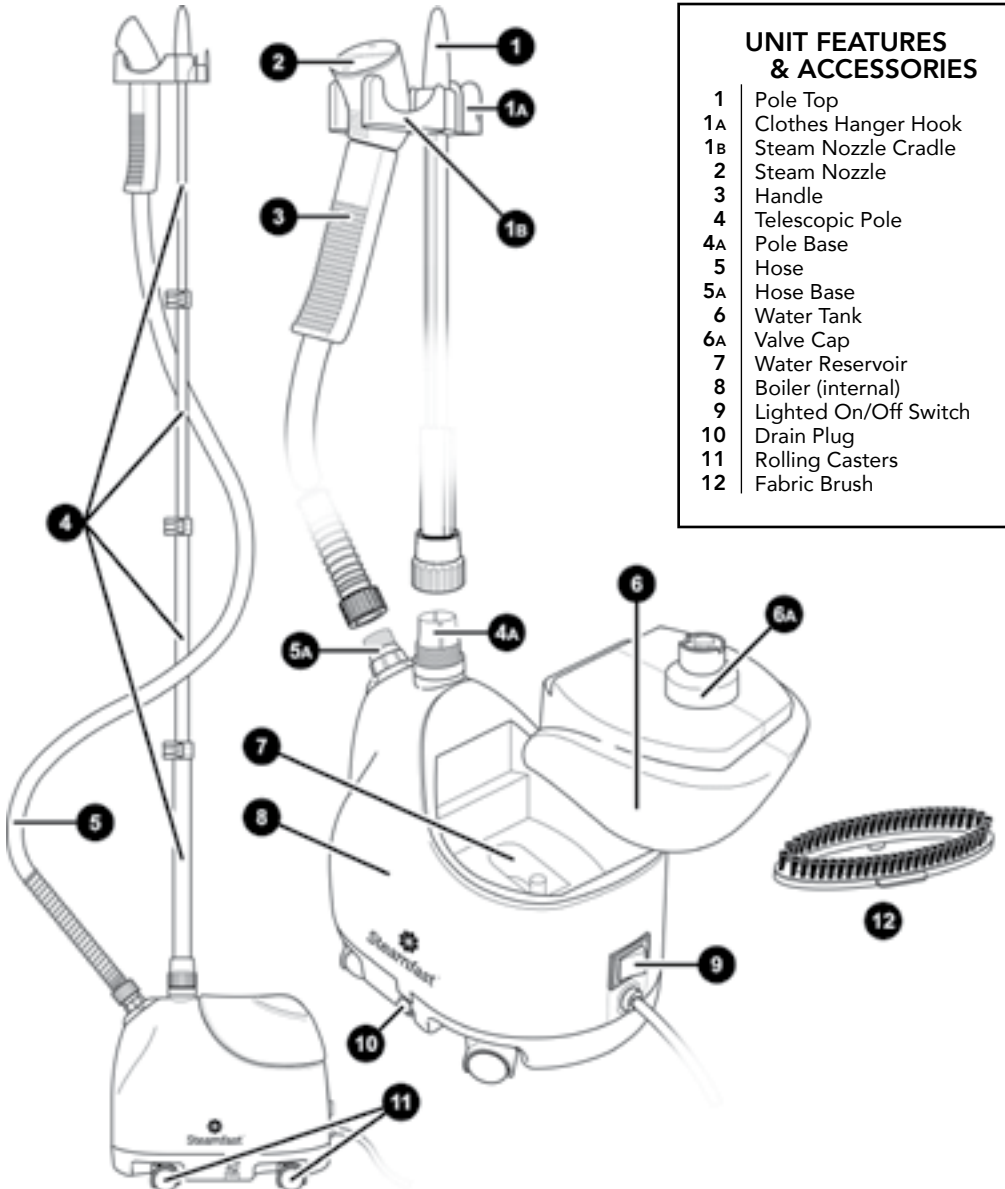

UNIT FEATURES & ACCESSORIES

- 1 Pole Top
- 1A Clothes Hanger Hook
- 1B Steam Nozzle Cradle
- 2 Steam Nozzle
- 3 Handle
- 4 Telescopic Pole
- 4A Pole Base
- 5 Hose
- 5A Hose Base
- 6 Water Tank
- 6A Valve Cap
- 7 Water Reservoir
- 8 Boiler (internal)
- 9 Lighted On/Off Switch
- 10 Drain Plug
- 11 Rolling Casters
- 12 Fabric Brush

-
- The *Pole Top* (1) connects to the top section of the *Telescopic Pole*. The *Pole Top* is comprised of the *Clothes Hanger Hook* and *Steam Nozzle Cradle*.
 - The *Clothes Hanger Hook* (1A) is designed to support garments hung from a clean rust-free hanger for easy, accessible steaming.
 - The *Steam Nozzle Cradle* (1B) provides a safe and convenient place to hang the *Steam Nozzle* when not in use.
 - The *Steam Nozzle* (2) emits the flow of hot, penetrating steam produced by the *Boiler*. The *Fabric Brush* connects to the *Steam Nozzle*.
 - The *Handle* (3) is engineered to stay cool while providing maximum grip and comfort.
 - The *Telescopic Pole* (4) connects to the main unit at the *Pole Base*. The *Telescopic Pole* is divided into four sections, three of which can be extended and lowered to a variety of heights for optimal user comfort and convenient storage.
 - The *Pole Base* (4A) is the threaded receptacle into which the *Telescopic Pole* is inserted and secured to the top of the main unit.
 - The *Hose* (5) directs steam flow from the main unit to the *Steam Nozzle*.
 - The *Hose Base* (5A) is the threaded receptacle onto which the *Hose* is screwed and secured to the front of the main unit.
 - The *Water Tank* (6) is the container that holds water to be transferred into the *Water Reservoir*. The *Water Tank* is removable for convenient filling, up to a maximum capacity of 50 oz (1479 ml).
 - The *Valve Cap* (6A) regulates the flow of water between the *Water Tank* and the *Water Reservoir*, and must be removed in order to fill the *Water Tank* with water.
 - The *Water Reservoir* (7) holds water before it is transferred to the *Boiler* and converted into steam.
 - The *Boiler* (8) is the internal heater where water transferred from the *Water Reservoir* is converted into steam.
 - The *Lighted On/Off Switch* (9) powers the unit on and off. When set to the "ON" position, it illuminates to provide a clear visual indication that the unit is receiving power.
 - The *Drain Plug* (10) is opened to easily empty the *Water Reservoir* of any remaining water.
 - The *Rolling Casters* (11) provide effortless mobility over a variety of surfaces.
 - The *Fabric Brush* (12) connects to the *Steam Nozzle* and is designed to brush away particles such as lint, hairs and loose threads.

TELESCOPIC POLE

The Telescopic Pole is made up of four sections (FIGURE 1):

- TOP (SECTION 1)
- MIDDLE-TOP (SECTION 2)
- MIDDLE-BOTTOM (SECTION 3)
- BOTTOM (SECTION 4)

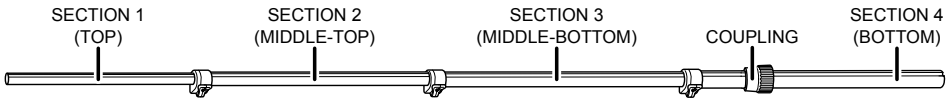

FIGURE 1

SECTIONS 1, 2 & 3 are adjustable in length. By using the three extension locks, these sections may be extended or retracted in order to achieve the desired length. Refer to **Adjusting Telescopic Pole** section below for more details.

NOTE: SECTION 4 (BOTTOM) is the widest section of the Telescopic Pole. This section includes the COUPLING, which secures the Telescopic Pole to the Pole Base.

CONNECTING TELESCOPIC POLE

1. Locate COUPLING on SECTION 4 of Telescopic Pole. The Telescopic Pole is packed with COUPLING already on SECTION 4 – if the COUPLING has fallen off, simply slide it back on as shown in FIGURE 1.
2. Look down inside Pole Base, and locate two guide ridges (FIGURE 2-A). Align two guide grooves on Telescopic Pole (FIGURE 2-B) with guide ridges inside Pole Base.
3. With guide grooves aligned with guide ridges, insert SECTION 4 of Telescopic Pole into Pole Base (FIGURE 2-C).

NOTE: If you have trouble locating two guide ridges inside Pole Base, insert SECTION 4 of Telescopic Pole into Pole Base, then twist Pole to properly align the guide grooves and guide ridges.

4. Slide COUPLING down over Pole Base, then screw clockwise to lock Telescopic Pole in place (FIGURE 2-D). Telescopic Pole should now be secured to the Pole Base.

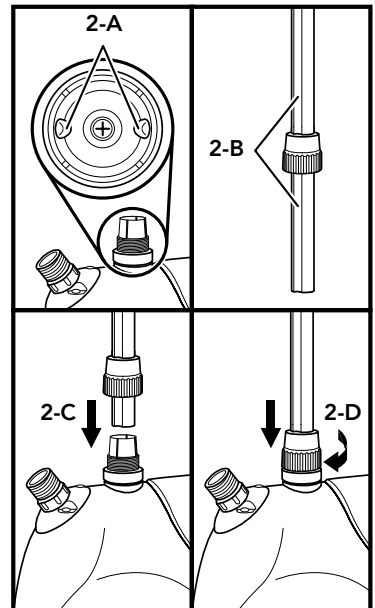

FIGURE 2

CONNECTING POLE TOP

1. Look at underside of Pole Top, and locate two guide ridges (FIGURE 3-A).
2. Align Pole Top guide ridges with guide grooves on SECTION 1 of Telescopic Pole. Be sure to orient Pole Top so that Steam Nozzle Cradle faces toward front of unit. This will help to improve unit stability when heavy garments are hung from the Clothes Hanger Hook.
3. Slide Pole Top onto SECTION 1 of Telescopic Pole (FIGURE 3-B). Press down firmly until Pole Top fits securely in place.

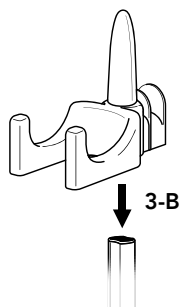
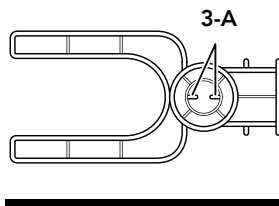

FIGURE 3

ADJUSTING TELESCOPIC POLE

In order to adjust the length of SECTIONS 1, 2 & 3 of the Telescopic Pole:

1. Release extension lock directly below SECTION 1 by swinging hinge outward as shown. SECTION 1 can then be extended / retracted (FIGURE 4).
2. Once SECTION 1 is at desired length, close hinge to once again secure extension lock.
3. Repeat **STEPS 1 & 2** for SECTIONS 2 & 3 of the Telescopic Pole, using the extension lock directly below each of those sections.

NOTE: It is recommended to extend Telescopic Pole to its full height during steamer operation; this will ensure optimal steam flow through the Hose.

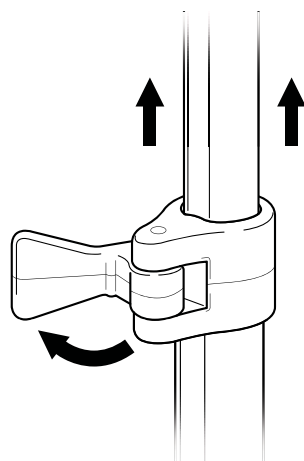

FIGURE 4

CONNECTING HOSE

1. Place end of Hose onto threaded Hose Base (FIGURE 5-A).
2. Rotate coupling in clockwise direction until Hose is tightly secured onto Hose Base (FIGURE 5-B). Hand tighten only. Do not over-tighten.
3. Hang Steam Nozzle on specially designed Steam Nozzle Cradle (FIGURE 5-C).

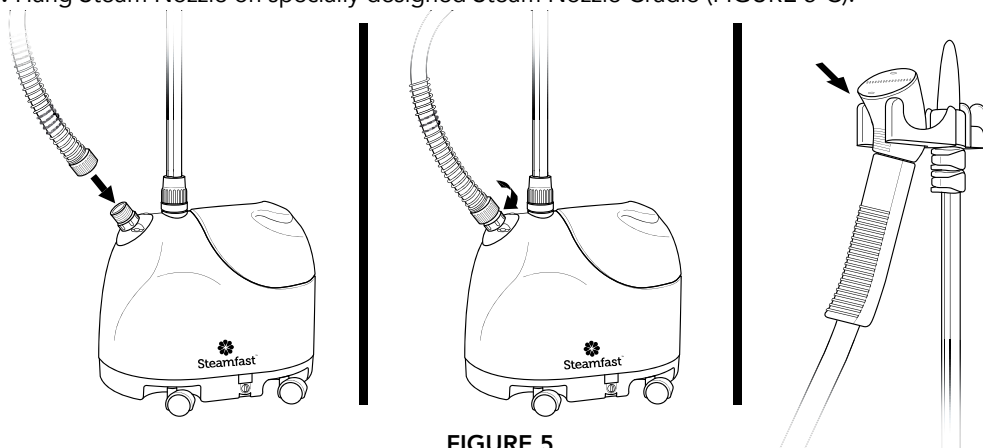

FIGURE 5

CAUTION: To prevent steam from causing bodily injury or damage to surfaces, always hang Steam Nozzle on Steam Nozzle Cradle when not in use. Do not lay Hose on the floor as condensation may build up, causing unwanted water droplets in the steam. Do not pull on the Hose with excessive force as this may damage it, resulting in a steam leak.

CONNECTING FABRIC BRUSH

1. Make sure Lighted On/Off Switch is set to "OFF" position, and that unit is not emitting any steam.

CAUTION: Do not try to connect Fabric Brush while unit is emitting steam, as this can cause burns and injury.

2. Align the four pegs on back of Fabric Brush (2 circular and 2 elliptical) with corresponding holes on face of Steam Nozzle.
3. Press Fabric Brush firmly onto Steam Nozzle, until it fits snugly and firmly in place (FIGURE 6).

Your new SF-407 Everyday Fabric Steamer is now fully assembled and ready for use. Please continue reading this manual for instructions on using the Everyday Fabric Steamer, as well as directions for proper cleaning, storage and troubleshooting.

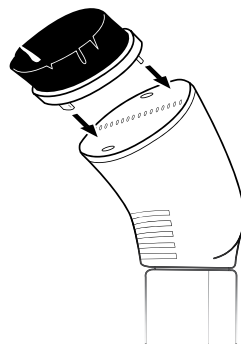

FIGURE 6

FILLING WITH WATER

1. Remove Water Tank from main unit.
2. Holding Water Tank upside-down, unscrew and remove Valve Cap by rotating it in a counter-clockwise direction (FIGURE 7-A).
3. Fill Water Tank with water through Valve Cap hole.

NOTE: In order to minimize potential mineral build-up and prolong the life of your Everyday Fabric Steamer, distilled or de-mineralized water is recommended.

CAUTION: Only water should be used in unit – other chemicals or cleaning agents may cause internal damage. Do not attempt to substitute any other water tank for the one designed for use with this unit.

4. Replace Valve Cap by rotating it in a clockwise direction.
5. Place Water Tank back onto main unit (FIGURE 7-B). The sound of water flowing from Water Tank into Water Reservoir should be audible for a short period of time.

NOTE: Water Tank can be removed and refilled at any time during operation – there is no need to turn unit off or allow any cooling period.

IMPORTANT: Do not attempt to operate unit with an empty Water Tank.

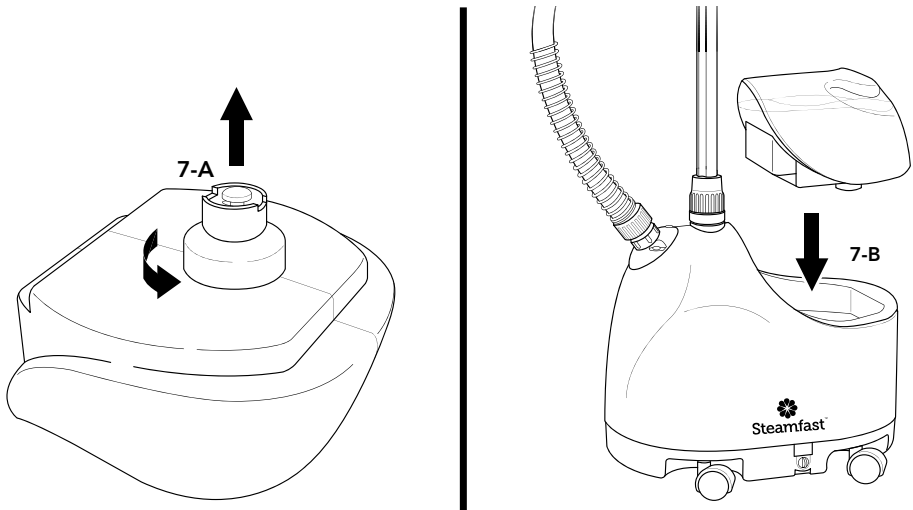

FIGURE 7

OPERATING YOUR EVERYDAY FABRIC STEAMER

NOTE: Be sure that Water Tank has been filled and, if desired, the Fabric Brush is connected before following these steps.

1. For first-time use, remove protective plastic cover that is shipped on electrical plug. Plug power cord into a convenient 3-prong electrical outlet (FIGURE 8-A).

CAUTION: This unit uses a grounded (3-prong) electrical plug. Use only in properly installed 3-prong electrical outlets. Do not attempt to alter plug or circumvent this safety feature in any way.

2. Set Lighted On/Off Switch to "ON" position (FIGURE 8-B), and verify that switch is illuminated.
3. After approximately 40 seconds of heating time, unit will begin producing a flow of steam from Steam Nozzle.

NOTE: It is common for the unit to produce gurgling sounds and small amounts of water during the first few minutes of steaming. This is due to water condensation inside cold Hose, and should be reduced as the Hose heats up. Pointing Steam Nozzle downward and shaking it may help to remove excess water from Hose more quickly (FIGURE 8-C).

4. Once steam flow is steady and excess condensation has been removed from Hose, you may proceed with your steaming tasks. Refer to **Fabric Steaming** section on Page 11 for more information about steaming garments and other fabrics.

CAUTION: Always be sure that Steam Nozzle is pointed in a safe direction (away from yourself, other people, pets and plants) when steaming.

5. When you are finished using the Everyday Fabric Steamer, immediately set Lighted On/Off switch to "OFF" position and unplug power cord from electrical outlet. Refer to **Storage & Care** on Page 12 for proper cleaning and storage procedures.

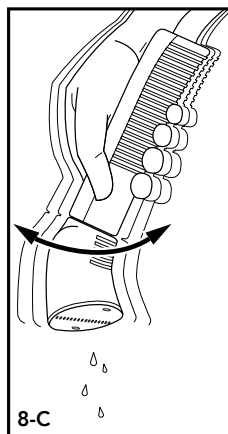
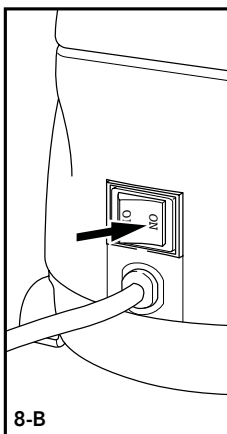
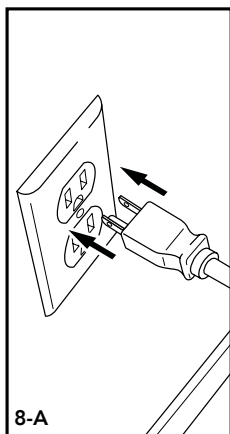

FIGURE 8

FABRIC STEAMING

STEAMING GARMENTS:

1. Place garment on a clean, rust-free clothes hanger.
2. Place hanger (with garment) on Clothes Hanger Hook (FIGURE 9-A).

CAUTION: Use care when handling garments on the Clothes Hanger Hook. Pulling on the garment with too much force may cause the unit to tip over.

3. Direct Steam Nozzle towards bottom of garment. Steam will rise along inside and outside of fabric, removing wrinkles. Slowly slide Steam Nozzle vertically, from bottom to top of garment (FIGURE 9-B).

NOTE: Do not allow kinks to form in Hose at any time during use.

4. Direct Steam Nozzle away from garment and smooth fabric with your free hand.
5. Repeat STEPS 3 & 4 as necessary until fabric is fresh and wrinkle-free.

GENERAL STEAMING TIPS:

- For most effective results, hold Steam Nozzle within 1/2" of fabrics, or press it directly against surfaces.
- Curtains and draperies can be steamed while still hanging.
- To remove wrinkles from towels, handkerchiefs and napkins, drape them over a rod or towel rack and gently steam them.
- Heavier fabrics may require repeated steaming to achieve desired results.
- To remove exceptionally stubborn wrinkles, steam both sides of fabric.
- Be especially careful when steaming any delicate fabrics that may be damaged by heat or water spotting.
- To sanitize a fabric, hold Steam Nozzle within 1/2 inch of a single area for at least 5 seconds. Use caution when doing this on more delicate fabrics.
- To remove particles like lint, hairs and loose threads, connect the Fabric Brush to the Steam Nozzle.



FIGURE 9

PROPER STORAGE

Preparing your Everyday Fabric Steamer for storage is quick and simple. When you have finished your steaming tasks, follow the steps listed below.

1. Set Lighted On/Off Switch to “OFF” position, and unplug power cord from electrical outlet.
2. Allow unit to cool (15 minutes for complete cooling).
3. Bring unit to a convenient sink or tub.
4. Remove Water Tank from unit. Unscrew Valve Cap and drain all remaining water from Water Tank. Replace Valve Cap when finished.
5. Open Drain Plug and drain all remaining water from Water Reservoir to prevent overflowing during your next use. Securely replace Drain Plug and place empty Water Tank back onto main unit.
6. For storage convenience, you may wish to collapse Telescopic Pole to its most compact height (refer to Page 7 for details).
7. Loosely bundle power cord and store Everyday Fabric Steamer in a cool dry location, along with all included accessories.

MINERAL BUILD-UP

A common maintenance need for steam appliances is the removal of build-up caused by high mineral content in many municipal water supplies. This mineral build-up may limit the effectiveness and reduce the life of your Everyday Fabric Steamer.

The best way to minimize mineral build-up is to use distilled or de-mineralized water when using your Everyday Fabric Steamer. In addition, it is recommended that the unit be cleaned at least once a month in order to remove any deposits that form. This will help to extend the life of your Everyday Fabric Steamer and keep it functioning at its maximum potential.

To remove mineral build-up:

1. Set Lighted On/Off Switch to “OFF” position and unplug power cord from electrical outlet.
2. Allow unit to cool (15 minutes for complete cooling).
3. Bring unit to a convenient sink or tub.
4. Remove Water Tank from unit. Unscrew Valve Cap and drain all remaining water from Water Tank.
5. Open Drain Plug and drain all remaining water from Water Reservoir. Securely replace Drain Plug.
6. Fill a measuring cup (not included) with 12 oz (355 ml) vinegar.
7. Pour vinegar into Water Tank, then replace Valve Cap and place Water Tank back onto main unit.
8. Allow vinegar to flow into Water Reservoir / Boiler and soak for 30-40 minutes.
9. Plug power cord into an electrical outlet and set Lighted On/Off Switch to “ON” position. Allow unit to steam until no vinegar remains.
10. Open Drain Plug and drain vinegar from Water Reservoir. Securely replace Drain Plug.
11. Remove and refill Water Tank to maximum capacity (50 oz / 11479 ml) with fresh water and place it back onto main unit. Allow all fresh water to flow into Water Reservoir / Boiler and be steamed out. Refill and repeat as necessary until vinegar odor has completely dissipated.
12. When finished, set Lighted On/Off Switch to “OFF” position and unplug power cord from electrical outlet. Follow normal storage procedure as outlined in **Proper Storage** section above.

PROBLEM	POSSIBLE CAUSE	SOLUTION
Unit fails to heat up. Lighted On/Off Switch DOES NOT illuminate when set to "ON" position.	Unit is not plugged in.	Plug power cord into electrical outlet.
	Household circuit breaker / ground fault interrupter has tripped or blown a fuse.	Reset circuit breaker / ground fault interrupter, or replace fuse. For assistance, contact a licensed electrician.
	Unit is damaged or otherwise in need of repair.	Immediately cease usage and unplug. Contact Consumer Service for assistance (see below for details).
Unit fails to heat up. Lighted On/Off Switch DOES illuminate when set to "ON" position. NOTE: Always allow sufficient time for unit to heat up and begin producing steam.	No water in unit.	Refer to Filling With Water procedure on Page 9 to fill unit with water.
	Mineral build-up in unit.	Refer to Mineral Build-up section on Page 12 for cleaning procedure.
	Unit is damaged or otherwise in need of repair.	Immediately cease usage and unplug. Contact Consumer Service for assistance (see below for details).
Excessive gurgling in Hose and Steam Nozzle / water drips from Steam Nozzle.	Condensation build-up inside of Hose.	Some gurgling is a natural effect of the steaming process. For excessive gurgling or dripping water, point Steam Nozzle downward and shake thoroughly to remove excess water droplets.
Steam output is weak or intermittent.	Water level in Water Reservoir is running low.	Refer to Filling With Water procedure on Page 9 to refill unit with water.
	Mineral build-up in unit.	Refer to Mineral Build-up section on Page 12 for cleaning procedure.

CONSUMER SERVICES

For problems with your Everyday Fabric Steamer, please refer to the troubleshooting guide located above. Additional inquiries should be directed to our consumer support services through our Web site, www.steamfast.com.

If you do not have internet access, you may also contact our Consumer Service Department by telephone, at **1-800-711-6617**.

NOTE: In order for our Consumer Service representatives to help you as quickly and efficiently as possible, please have the following information ready before calling:

- Purchase information (where and when you purchased this product)
- Copy of purchase receipt / proof of purchase
- Product serial number (located near electrical specification label on bottom of unit)
- Date code (4-digit number located on electrical specification label on bottom of unit)

For information regarding your 2 year limited warranty, refer to Page 15 of this manual.

REPLACEMENT ACCESSORIES

When ordering replacement accessories for your Everyday Fabric Steamer, you may refer to the part numbers below. Replacement accessories may be ordered through our Web site:

www.steamfast.com

You may also contact Consumer Service directly:

consumerservice@steamfast.com or 1-800-711-6617

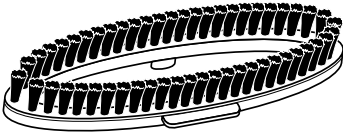

FABRIC BRUSH
A407-001R-

NOTE: Due to continuing improvements, part numbers listed above may change. For assistance ordering parts, please contact Consumer Service directly.

2-YEAR LIMITED WARRANTY

What is covered

Steamfast, a division of Vornado Air, LLC (“Steamfast”). Subject to the terms and conditions of this 2-Year Limited Warranty (“Warranty”) as set forth below, Steamfast warrants to the original consumer or purchaser (“Buyer”) that this Steamfast®-branded steam product, excluding all accessories and attachments, (the “Product”) is to be free from defects in material and workmanship for a period of two (2) years from the date of purchase when used and maintained in accordance with the Owner’s Guide (the “Warranty Period”). In the event Buyer notifies Steamfast of a defect in the Product within the Warranty Period, Steamfast will replace the Product and/or defective component parts, as applicable and necessary. Any such replacement will be made at no charge to Buyer for parts or labor, provided that Buyer shall be responsible for all shipping and transportation costs associated with returning the Product to Steamfast for inspection and covered replacement.

What is not covered

This Warranty shall not be applicable to damage or loss caused in whole or in part by:

- Repairs, modifications or alterations to the Product by anyone other than Steamfast.
- Use or operation of the Product outside the permitted or intended uses described by Steamfast in the Owner’s Guide, or other careless operation, handling, misuse, or abuse of the Product.
- Lack of proper maintenance or timely cleaning of the Product as specified in the Owner’s Guide.
- Use of the Product other than for normal household purposes.
- Normal wear and tear.
- Used consumable parts, accessories and attachments, including, but not limited to, brushes, hangers, scrub pads and mop pads.
- Use of parts and accessories other than those produced or recommended by Steamfast.
- Cosmetic damage, such as scratches, nicks and dents.
- Damage caused by accident, water, flood, fire or other acts of nature or external causes.

Warranty limitations and exclusions

- NO OTHER EXPRESS WARRANTY IS GIVEN BY STEAMFAST TO BUYER AND NO REPRESENTATIVE HAS THE AUTHORITY TO MAKE REPRESENTATIONS OTHER THAN THOSE PROVIDED HEREIN.
- THERE ARE NO WARRANTIES WHICH EXTEND BEYOND THE DESCRIPTION ON THE FACE HEREOF AND ALL IMPLIED WARRANTIES, SPECIFICALLY THE IMPLIED WARRANTIES OF MERCHANTABILITY AND FITNESS FOR A PARTICULAR PURPOSE, ARE HEREBY EXPRESSLY LIMITED TO THE DURATION OF THE WARRANTY PERIOD, UNLESS A SHORTER PERIOD IS PERMITTED BY LAW.
- STEAMFAST’S REPLACEMENT OF THE PRODUCT IS THE EXCLUSIVE REMEDY. UNDER NO CIRCUMSTANCES SHALL STEAMFAST BE LIABLE TO BUYER OR ANY OTHER PERSON FOR ANY INCIDENTAL, SPECIAL, CONSEQUENTIAL, OR OTHER DAMAGES, EVEN IF STEAMFAST HAS BEEN ADVISED OF OR COULD REASONABLY FORESEE THE POSSIBILITY OF SUCH DAMAGES, INCLUDING, BUT NOT LIMITED TO, LOSS OF PROFITS OR DAMAGE, WHETHER ARISING OUT OF BREACH OF WARRANTY, BREACH OF CONTRACT OR UNDER ANY OTHER THEORY OF LAW.

- THIS WARRANTY GIVES BUYER SPECIFIC LEGAL RIGHTS. BUYER MAY ALSO HAVE OTHER RIGHTS WHICH VARY FROM STATE-TO-STATE. SOME STATES DO NOT ALLOW THE EXCLUSION OR LIMITATION OF INCIDENTAL OR CONSEQUENTIAL DAMAGES, AND SOME STATES DO NOT ALLOW LIMITATIONS ON HOW LONG AN IMPLIED WARRANTY LASTS, SO THE ABOVE LIMITATION OR EXCLUSION MAY NOT APPLY TO BUYER.

How do you register the Warranty

Buyer must complete an application to register this Warranty within sixty (60) days following date of purchase. Buyer may either visit Steamfast's website at www.steamfast.com and complete an online application or mail a completed application to Steamfast. Failure to register this Warranty within sixty (60) days following date of purchase will render this Warranty null and void.

Warranty service

For warranty service, call 1-800-711-6617 or email consumerservice@steamfast.com to obtain a Return Authorization ("RA") form. Include the Product model number and serial number, as well as Buyer's name, address, city, state, zip code and phone number when contacting Steamfast for warranty service. Buyer may be required to provide the original sales receipt for purposes of verifying date of purchase. After receiving the RA form, the Product must be shipped, postage prepaid by Buyer, to:

Steamfast
Attn: Warranty & Repair
415 E. 13th Street
Andover, KS 67002

To assure proper handling, packages must be clearly marked with the RA number. Packages not clearly marked with the RA number may be refused at the receiving dock.

Important: After receiving return authorization, carefully pack the Product to avoid damage in shipping. Damage in shipping is not covered by the Warranty and shall be the sole responsibility of Buyer. Damage or loss not covered by this Warranty or occurring outside the Warranty Period will require a fee to cover the cost of handling and shipping. All such fees and costs shall be the sole responsibility of Buyer.

Please allow at least 1-2 weeks for return of the Product after it is received by Steamfast. For ease of recordkeeping, it is recommended that Buyer staple or attached the original sales receipt to this Owner's Guide and record the Product serial number (located on the Product specifications decal) here:

© 2018 Vornado Air, LLC • Andover, KS 67002

Specifications subject to change without notice. Steamfast® is a trademark owned by Vornado Air, LLC.

Manufactured in China.

Steamfast Consumer Service W: www.steamfast.com • P: 1-800-711-6617 •

E: consumerservice@steamfast.com

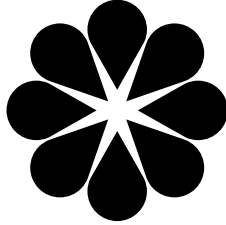

SteamfastTM

Steamfast

415 East 13th, Andover, KS 67002

1-800-711-6617 | steamfast.com | consumerservice@steamfast.com