

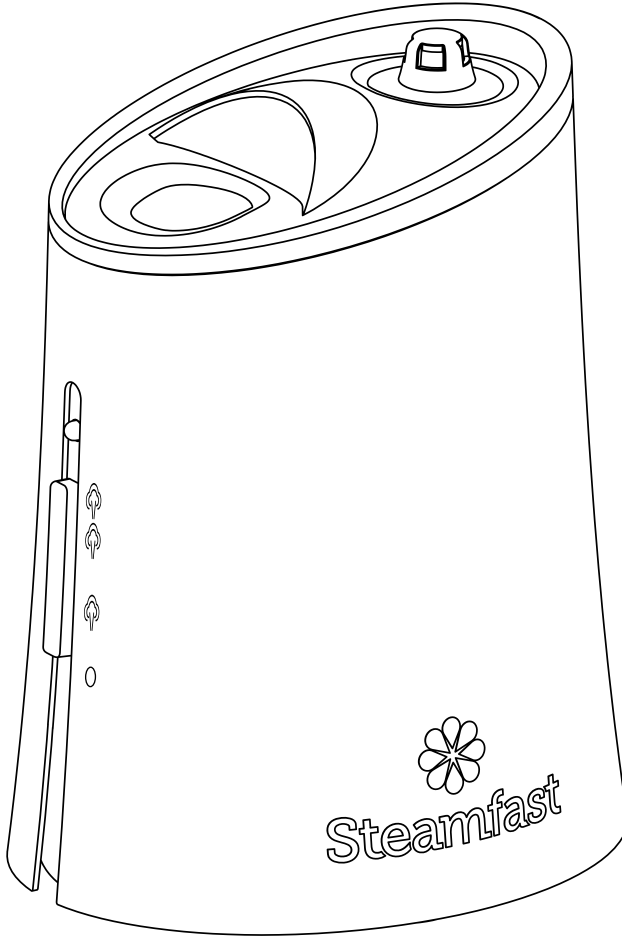

Steamfast™



Steam Humidifier Owner's Guide

READ AND SAVE THESE INSTRUCTIONS

IMPORTANT SAFETY INSTRUCTIONS

This owner's guide and any additional inserts are considered part of the product. They contain important information about safety, use and disposal. Before using the product, please familiarize yourself with all operating and safety instructions. Please keep all documents for future reference and pass these documents on, together with the product, to any future owner. See our website to view, download and print the most current version of this owner's guide.

INTENDED USE: This product is intended to humidify and circulate the air in indoor living spaces only in the United States and Canada. This product is not intended for commercial or industrial use. The manufacturer assumes no responsibility for damage or injury due to unauthorized use or product modification. Failure to follow these directions will void the product warranty.

WARNING: Risk to Children and Impaired Persons. Supervision is required during the installation, operation, cleaning and maintenance of this product by children under age 12 and anyone with reduced physical, sensory or mental capabilities. Children should be supervised to ensure that they do not play with the appliance, its parts and packaging material.

INSTALLATION WARNING—To reduce risk of fire, electrical shock and injury to persons, observe the following:

1. No part of this product (the appliance, power cord, plug, packaging, etc.) should be placed near furnaces, fireplaces, stoves or other high temperature heat sources. Do not use in a window, on an uneven or unstable surface, or near water.
2. The appliance, power supply, power cord and plug cannot come into contact with water. Do not use this product on wet surfaces. Do not use this product in a bathtub or shower or position product where it may fall into a bathtub, laundry, swimming pool or other water container. Do not use this product outdoors or expose it weather or elements.
3. Do not run cord under carpeting. Do not cover cord with throw rugs, runners, or similar coverings. Do not route under furniture or appliances. Arrange cord away from traffic area and where it will not be tripped over. The cord should not hang over edges of counters or be placed where it can be crimped or closed in doors. Place appliance near an easily accessible outlet so the product can be unplugged quickly during an emergency.

SAFE USE WARNING—To reduce risk of fire, electrical shock and injury to persons, observe the following:

1. **WARNING:** To reduce likelihood of circuit overload, fire and electric shock, do not operate with a solid state speed device, such as a dimmer control switch.
2. Do not operate unit if the unit has been dropped or damaged. Do not use this product if it has a damaged power cord or plug. To avoid risk of electrical shock, do not attempt to repair or replace parts. Only original replacement parts may be used. If the power cord is damaged, it must be replaced by the manufacturer, its service agent, or similarly qualified persons in order to avoid a hazard. Contact Consumer Service at 1-800-711-6617 or consumerservice@steamfast.com for further instructions about replacement and repair.
3. Risk of fire. Your appliance may be equipped with a detachable power supply or a cord. Use only the power cord and plug provided.
4. Before plugging power cord into electrical outlet, be sure that all electrical information on the rating label, including voltage, is compatible with your outlet's power supply.
5. Never use the cord as a handle or otherwise yank, strain or stretch the power cord.
6. While the product is plugged in, do not insert or allow foreign objects to enter any input or output opening as this may cause risk of electric shock or fire, or damage the product.
7. A loose fit between wall outlet (receptacle) and plug may cause overheating and distortion of the plug. Discontinue use of the product in this outlet. Contact a qualified electrician to replace loose or worn outlets.

8. This appliance has a polarized plug (one blade is wider than the other.) To reduce the risk of electrical shock, this plug is intended to fit in a polarized outlet only one way. If the plug does not fit fully in the outlet, reverse the plug. If it still does not fit, contact a qualified electrician. Do not attempt to defeat this safety feature.
9. Before filling with water, moving, repositioning, servicing, cleaning and when not in use, use the product controls to turn off the power and then unplug. To disconnect from outlet, grasp and pull only the plug. Also, power off and unplug if the product will be left unattended for an extended period of time or during electrical storms.
10. Electric shock can occur when liquid comes in contact with electricity. Be careful when removing the water tank and refilling to avoid electric shock.
11. Turn the humidifier off if the relative humidity exceeds 60%. Humidity levels above 60% may allow moisture to build up indoors and condense on surfaces, where microorganisms can settle and grow. For accurate readings, use a hygrometer which is available at most hardware stores and home centers.

SERVICING WARNING—To reduce risk of fire, electrical shock and injury to persons, observe the following:

1. Clean your product regularly, only as is instructed in this manual. Prior to cleaning, turn off the power on your product and unplug. Do not use gasoline, thinners, solvents, ammonias or other chemicals for cleaning. Refer to the CLEANING instructions provided.
2. Do not open appliance housing while product is plugged in. To avoid risk of shock, all service and/or repairs must be done by a Authorized Service Center.
3. Protect against the growth of mold, mildew and other microorganisms by emptying the water tank immediately after each use. If water is left in the tank for longer than 8 hours, thoroughly clean and disinfect the unit as described in the section of this Owner's Guide referenced as "CLEANING".

FCC CONSUMER ADVISEMENT: This equipment may generate, use and/or radiate radio frequency energy that may cause harmful interference to radio communications. If this equipment does cause harmful interference to radio or television reception, which can be determined by turning the equipment off and on, the user is encouraged to contact Consumer Service at 1-800-711-6617. Changes or modifications to this unit not expressly approved by the party responsible for compliance could void the user's authority to operate the equipment.

DISPOSAL WARNING

To reduce waste and environmental harm, observe the following:



PACKAGE RECYCLING: The packaging protects the appliance from transport damage. The packaging materials are selected from the point of view of their environmental friendliness and disposal technology and are therefore recyclable. Dispose of all packaging materials in an environmentally responsible manner.

SAVE THESE INSTRUCTIONS

Questions or comments?

- steamfast.com
- consumerservice@steamfast.com
- 1-800-711-6617

Speak your mind! We invite you to review this product online:
steamfast.com/reviews

The following features and accessories are included with your Steam Humidifier. Carefully inspect the packing material for all parts listed below. To obtain possible missing parts, refer to **Product Support** for Consumer Service contact information.

UNIT FEATURES

- 1 | Water Tank Lid
- 2 | Steam Outlet
- 3 | Essential Oils Ring
- 4 | Top-fill Inlet
- 5 | Max-fill Ball
- 6 | Steam Chamber
- 7 | Water Tank
- 8 | Power Indicator Light
- 9 | Power/Steam Selection Switch
- 10 | Heating Element (Internal)

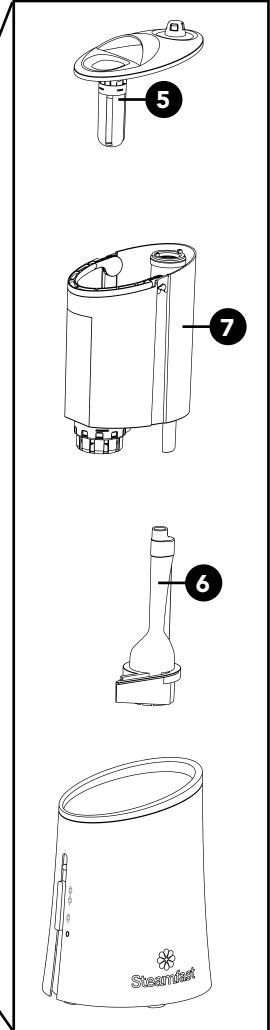
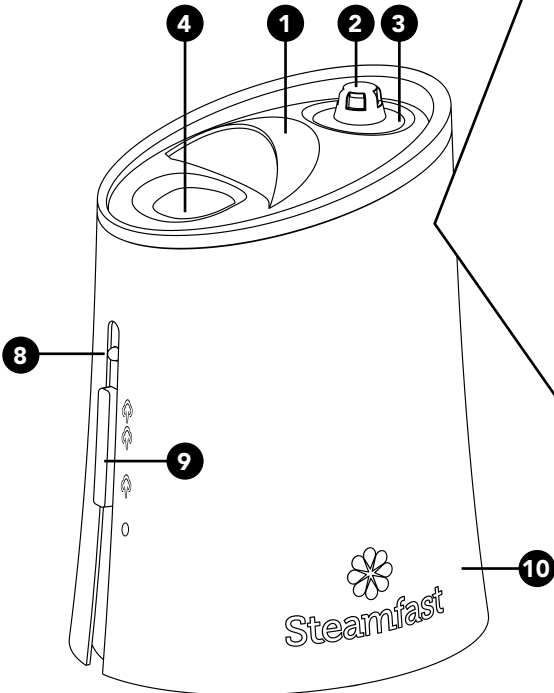

FILLING WATER TANK

NOTE: Spills can occur during cleaning, moving or filling the Water Tank, so be careful to avoid spills when doing these activities.

NOTE: Do not add any extra ingredients (fragrances, medication) to the water.

1. Turn the Power Switch to Off, then unplug and place unit on a level surface.
2. Fill by removing Water Tank or by top fill.
 - a. **Water Tank Fill** – Remove Water Tank Lid and pull Water Tank out of unit by handle. Fill with clean cool tap water to MAX fill (approx. 100oz). Place Water Tank back in unit and replace Water Tank Lid.

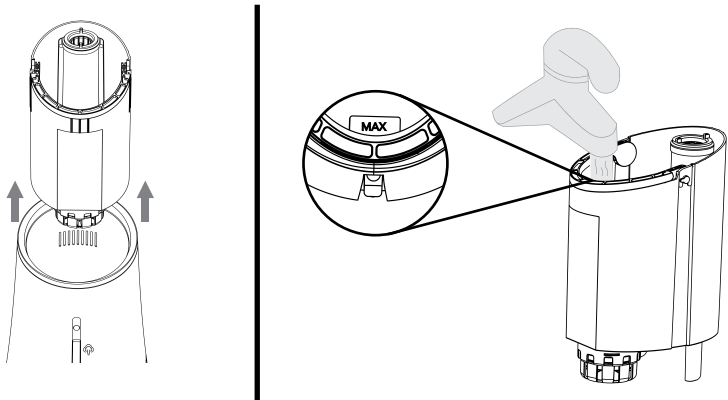

- b. **Top Fill** – Using a measuring cup or pitcher, pour approx. 100oz of cool tap water into top fill opening until float ball reaches top of tube.

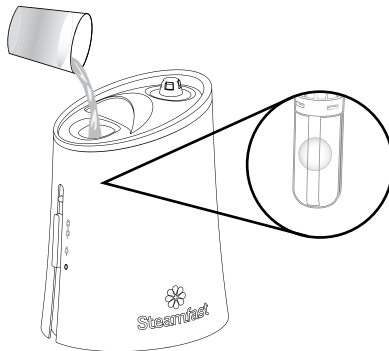

WARNING: Keep out of reach of children and pets. This product produces HOT STEAM and should be placed in an area not accessible to children or pets. Ensure power cord is also securely out of reach.

OPERATING INSTRUCTIONS

1. Please check the Water Tank is filled, the Steam Chamber and Water Tank Lid are in place before operating.
2. Plug the power cord into a power outlet.
3. Select desired humidity level by sliding the Power/Steam Selection Switch to Low (☁) or High (☁) humidity.

WARNING: Do not touch the hot steam.

4. Direct the steam outlet away from people, objects or walls.
NOTE: If humidity is too high, slide the Power/Steam Selection Switch to Low (☁) or power Off.
5. When filling the Water Tank, slide the Power/Steam Selection Switch to the Off position and unplug the unit. Fill the water as described under **Filling Water Tank**.

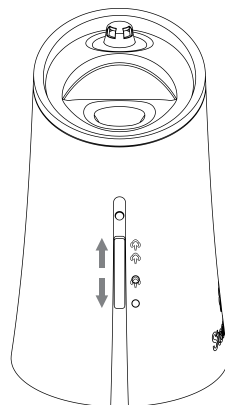

RESET INSTRUCTIONS

When the Water Tank is empty and water in the heating reservoir is almost empty, the Heating Element will automatically shut Off. The red reset light will illuminate to indicate the Water Tank needs to be refilled. In order to operate the humidifier again follow these instructions:

1. Turn the power switch to the Off position.
2. Fill the water as described under **Filling Water Tank**.
3. Allow humidifier to cool for approximately 1 minute, then power unit On.

HOW TO USE ESSENTIAL OIL RING

1. Add essential oils to Essential Oil Ring if desired.
NOTE: Do not overfill oil ring to prevent spilling.
2. Plug power cord into standard electrical outlet.
3. Use Power Switch to select Low (☁) or High (☁) steam.
4. After approximately 3 minutes, steam will begin emitting from Steam Outlet.
5. Do not add aroma oil anywhere other than oil ring.

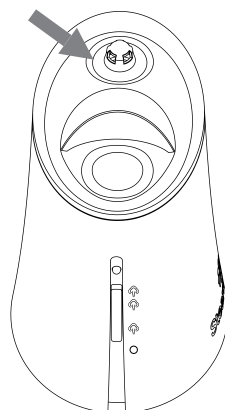

CLEANING

Proper cleaning of your Steam Humidifier is essential to the air quality and performance of your humidifier. The frequency in which your humidifier will need to be cleaned will vary depending on use, water hardness and outside environmental factors. It is recommended, assuming average use, to thoroughly clean the unit once a week, or when mineral deposits or other particles begin to form. Follow the steps listed below for proper cleaning:

NOTE: Do not use gasoline, thinners, solvents or other chemicals for cleaning.

WARNING: Always pour solutions out from the front of the unit so water does not enter the internal vents.

1. Slide Power/Steam Selection Switch to Off and unplug the unit.
2. Remove Water Tank Lid, Water Tank and Steam Chamber.
4. Empty all water inside of the Water Tank and any remaining water around the Heating Element.
5. Clean Water Tank and Steam Chamber with warm soapy water, then rinse with clean water.
6. Wipe dry with a soft cloth or paper towel.

NOTE: If the humidifier is turned Off with water inside and not turned back on for 8 hours or longer, or if humidifier is not cleaned as recommended, you may experience some growth of algae or bacteria.

TO REMOVE MINERAL BUILD-UP

1. Slide Power/Steam Selection Switch to Off and unplug the unit.
2. Remove Water Tank Lid, Water Tank and Steam Chamber.
3. Empty any remaining water around the Heating Element.
4. Pour 12oz white vinegar onto Heating Element and soak for 20-30 minutes, then gently scrub Heating Element with a soft brush or soft cloth to remove mineral deposits.

Note: Do not use hard brushes, steel wool or other abrasives on Heating Element. Doing so could damage the Heating Element.

5. Empty vinegar and rinse with clean warm water until you cannot detect any vinegar odor.

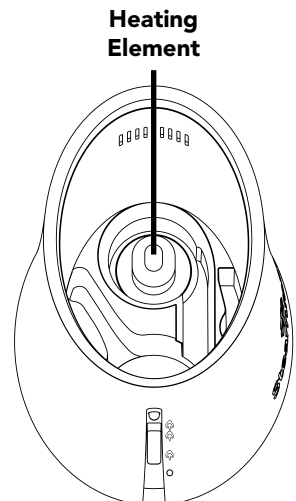

PROPER STORAGE

During the off-season or after extended periods of non-use, you may choose to store your humidifier. To ensure long life of the product, it is recommended to store your humidifier by following these instructions:

TIP – Cleaning is recommended before storage.

- 1.** Unplug power cord and bundle loosely.
- 2.** Let humidifier dry completely before storing. Do not store with water inside the Water Tank or around the Heating Element.
- 3.** Cover, or place back in retail carton if available. This will prevent humidifier from accumulating dust over time.
- 4.** Store humidifier in a cool and dry location.

PROBLEM	POSSIBLE CAUSE	SOLUTION
Unit Fails to Power On	Unit is not plugged in.	Plug power cord into electrical outlet.
	Household circuit breaker / ground fault interrupter has tripped or blown a fuse.	Reset circuit breaker / ground fault interrupter, or replace fuse. For assistance, contact a licensed electrician.
	Unit is damaged or otherwise in need of repair.	Immediately cease usage and unplug. Contact Consumer Service for assistance.
Indicator Light remains Red	Water level in Tank is empty or too low.	Refill with clean, cool tap water. See FILLING WATER TANK for instructions.
	Automatic shut off has not reset.	Turn unit off for 5 minutes to allow Automatic shut off to reset itself.
Unit is not Emitting Steam	Water level in Tank is empty or too low.	Refill with clean, cool tap water. See FILLING WATER TANK for instructions.
	Mineral build-up on Heating Element.	See CLEANING for instructions on how to remove mineral build-up.
Condensation forms around humidifier or on windows	Steam intensity is set too high for room size or pre-existing humidity level.	Decrease steam output to low setting and/or open door to room.

CONSUMER SERVICES

For problems with your Steam Humidifier, please refer to the troubleshooting guide located above. Additional inquiries should be directed to our consumer support services through our website, **steamfast.com**. If you do not have internet access, you may also contact our Consumer Service Department by telephone, at **1-800-711-6617** (Monday – Friday, 7 a.m. – 6 p.m. CST).

NOTE: In order for our Consumer Service representatives to help you as quickly and efficiently as possible, please have the following information ready before calling:

- **Purchase information (where and when you purchased this product).**
- **Copy of purchase receipt / proof of purchase.**
- **Product serial number (located near electrical specification label on bottom of unit).**

For information regarding your 1 year limited warranty, refer to **Warranty**.

PRODUCT SPECIFICATIONS

MODEL	SF-920
VOLTAGE	120V ~
WATTAGE	260W
AMPERAGE	2.17A
WATER CAPACITY	1 gal (3.8 L)
HEATING TIME	3 min (Approximate)
STEAM OUTPUT	2 gal per day (On High)
UNIT WEIGHT	5.26 lbs. (2.43 kg)
UNIT DIMENSIONS	10.08" (25.6 cm) x 12.05" (30.6 cm) x 15.75" (40.0 cm)
POWER CORD LENGTH	6' (183.0 cm)

1-YEAR LIMITED WARRANTY

What is covered

Steamfast, a division of Vornado Air, LLC ("Steamfast"). Subject to the terms and conditions of this 1-Year Limited Warranty ("Warranty") as set forth below, Steamfast warrants to the original consumer or purchaser ("Buyer") that this Steamfast®-branded steam product, excluding all accessories and attachments, (the "Product") is to be free from defects in material and workmanship for a period of one (1) year from the date of purchase when used and maintained in accordance with the Owner's Guide (the "Warranty Period"). In the event Buyer notifies Steamfast of a defect in the Product within the Warranty Period, Steamfast will replace the Product and/or defective component parts, as applicable and necessary. Any such replacement will be made at no charge to Buyer for parts or labor, provided that Buyer shall be responsible for all shipping and transportation costs associated with returning the Product to Steamfast for inspection and covered replacement.

What is not covered

This Warranty shall not be applicable to damage or loss caused in whole or in part by:

- Repairs, modifications or alterations to the Product by anyone other than Steamfast.
- Use or operation of the Product outside the permitted or intended uses described by Steamfast in the Owner's Guide, or other careless operation, handling, misuse, or abuse of the Product.
- Lack of proper maintenance or timely cleaning of the Product as specified in the Owner's Guide.
- Use of the Product other than for normal household purposes.
- Normal wear and tear.
- Used consumable parts, accessories and attachments, including, but not limited to, brushes, hangers, scrub pads and mop pads.
- Use of parts and accessories other than those produced or recommended by Steamfast.
- Cosmetic damage, such as scratches, nicks and dents.
- Damage caused by accident, water, flood, fire or other acts of nature or external causes.

Warranty limitations and exclusions

- NO OTHER EXPRESS WARRANTY IS GIVEN BY STEAMFAST TO BUYER AND NO REPRESENTATIVE HAS THE AUTHORITY TO MAKE REPRESENTATIONS OTHER THAN THOSE PROVIDED HEREIN.
- THERE ARE NO WARRANTIES WHICH EXTEND BEYOND THE DESCRIPTION ON THE FACE HEREOF AND ALL IMPLIED WARRANTIES, SPECIFICALLY THE IMPLIED WARRANTIES OF MERCHANTABILITY AND FITNESS FOR A PARTICULAR PURPOSE, ARE HEREBY EXPRESSLY LIMITED TO THE DURATION OF THE WARRANTY PERIOD, UNLESS A SHORTER PERIOD IS PERMITTED BY LAW.
- STEAMFAST'S REPLACEMENT OF THE PRODUCT IS THE EXCLUSIVE REMEDY. UNDER NO CIRCUMSTANCES SHALL STEAMFAST BE LIABLE TO BUYER OR ANY OTHER PERSON FOR ANY INCIDENTAL, SPECIAL, CONSEQUENTIAL, OR OTHER DAMAGES, EVEN IF STEAMFAST HAS BEEN ADVISED OF OR COULD REASONABLY FORESEE THE POSSIBILITY OF SUCH DAMAGES, INCLUDING, BUT NOT LIMITED TO, LOSS OF PROFITS OR DAMAGE, WHETHER ARISING OUT OF BREACH OF WARRANTY, BREACH OF CONTRACT OR UNDER ANY OTHER THEORY OF LAW.
- THIS WARRANTY GIVES BUYER SPECIFIC LEGAL RIGHTS. BUYER MAY ALSO HAVE OTHER RIGHTS WHICH VARY FROM STATE-TO-STATE. SOME STATES DO NOT ALLOW THE EXCLUSION OR LIMITATION OF INCIDENTAL OR CONSEQUENTIAL DAMAGES, AND SOME STATES DO NOT ALLOW LIMITATIONS ON HOW LONG AN IMPLIED WARRANTY LASTS, SO THE ABOVE LIMITATION OR EXCLUSION MAY NOT APPLY TO BUYER.

How do you register the Warranty

Buyer must complete an application to register this Warranty within sixty (60) days following date of purchase. Buyer may either visit Steamfast's website at steamfast.com and complete an online application or mail a completed application to Steamfast. Failure to register this Warranty within sixty (60) days following date of purchase will render this Warranty null and void.

Warranty service

For warranty service, call 1-800-711-6617 or email consumerservice@steamfast.com to obtain a Return Authorization ("RA") form. Include the Product model number and serial number, as well as Buyer's name, address, city, state, zip code and phone number when contacting Steamfast for warranty service. Buyer may be required to provide the original sales receipt for purposes of verifying date of purchase. After receiving the RA form, the Product must be shipped, postage prepaid by Buyer, to:

Steamfast
Attn: Warranty & Repair
415 E. 13th Street
Andover, KS 67002

To assure proper handling, packages must be clearly marked with the RA number. Packages not clearly marked with the RA number may be refused at the receiving dock.

Important: After receiving return authorization, carefully pack the Product to avoid damage in shipping. Damage in shipping is not covered by the Warranty and shall be the sole responsibility of Buyer. Damage or loss not covered by this Warranty or occurring outside the Warranty Period will require a fee to cover the cost of handling and shipping. All such fees and costs shall be the sole responsibility of Buyer.

Please allow at least 1-2 weeks for return of the Product after it is received by Steamfast. For ease of recordkeeping, it is recommended that Buyer staple or attached the original sales receipt to this Owner's Guide and record the Product serial number (located on the Product specifications decal) here:

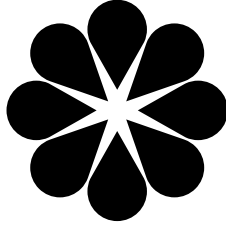

SteamfastTM

Steamfast

415 East 13th, Andover, KS 67002

1-800-711-6617 | steamfast.com | consumerservice@steamfast.com